



DEMO BOARD TEST REPORT

NO-Y 12V1.5A Adapter using QR PSR Power Switch KP21824

FEATURES

- No Y-Cap Design
- Primary Side Regulation without Opto-Coupler and Secondary Side Feedback Circuit
- High Precision 12V Output
- Meet DoE Level VI and CoC V5 Tier2
- Less than 70mW Standby Power
- >6dB Margin for CE and RE Test
- Strong ESD Capability (9kV/16kV)
- Good Line and Load Regulation
- Single Failure Protections for Power Supply

APPLICATIONS

- STB Power Supply
- Network Power Supply

DEMO BOARD SEPCIFICATION

Description	Symbol	Min.	Typ.	Max.	Unit	Note
Input Voltage	V_{in}	90	-	265	V _{ac}	50/60Hz
Output Voltage	V_{out}	-	12	-	V _{dc}	
Output Current	I_{out}	-	1.5	1.88	A	
Total Output Power	P_{out}	-	18	-	W	
Ripple & Noise	V_{ripple}	-	-	90	mV _{p-p}	Line End (AWG 22#, 1.5m), 20MHz Bandwidth
System Average Efficiency	η	>85.5			%	Meets DoE Level VI and CoC V5 Tier2, Line End (AWG 22#, 1.5m)
Standby Power Consumption	P_{st}			62.01	mW	@230Vac/50Hz
Startup Time	T_{st}	-	1.9	-	s	Tested at 90Vac/60Hz
Conductive EMI Margin	-	+6	-	-	dB	EN55022
Radiant EMI Margin	-	+6	-	-	dB	EN55032
Surge Test	-	>4	-	-	KV	Differential Mode @ 220Vac/50Hz
	-	>4	-	-	kV	Common Mode @ 220Vac/50Hz
ESD (Contact/Air Discharge)	-	8/15	-	-	kV	On each Output Terminals +/-
Operating Ambient	-	0	-	40	°C	
Operating Humidity	-	5	-	95	%R.H.	

INTRODUCTION

KP21824 is a high performance QR PSR power switch ideal for offline fly-back converter applications.

At full load, KP21824 operates in QR mode to optimize efficiency and thermal performance. The IC operates in FM+AM mode under normal and light load, which can reduce audio noise and achieve less than 75mW standby power.

The Demo Board of KP21824-D02 is typically designed for 12V/1.5A adapter with universal input (90-265Vac,60/50Hz). The demo board adopts NO-Y design and meets CoC V5 Tier2, EN55022 ClassB EMI Standard with comprehensive protections. Besides, the demo board has strong ESD capability (9kV/16kV), good line and load regulation.

Demo Board of KP21824-D02



Board Size (in mm): L x W x H= 66.8mm x 34.9mm x 24.32mm

Schematic

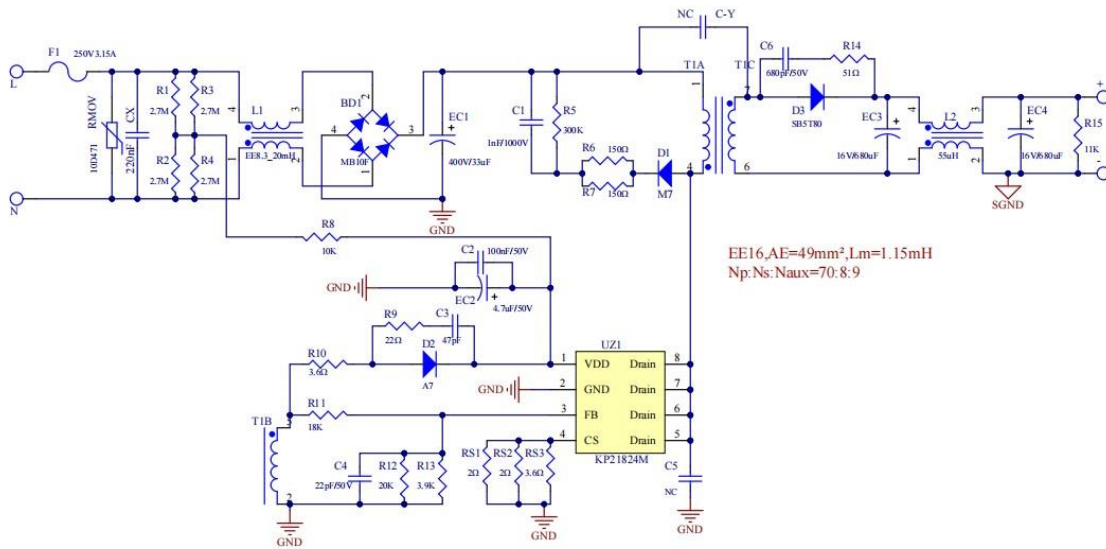

Printed Circuit Board Layout

Top Layer

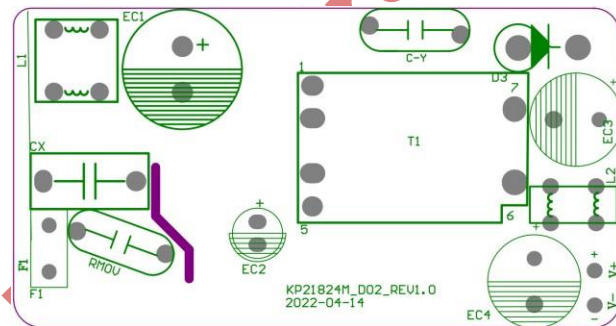

Bottom Layer

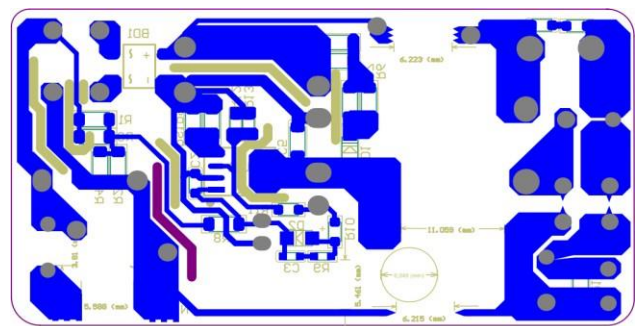



Demo Board Test Report ----NO-Y 12V1.5A Adapter using QR PSR Power Switch KP21824

Bill of Material

No.	Designator	Value	Description	Package	Manufacturer	Part Number
1	RMOV	470V	Disk Varistor HighSurge WE-VD	TH	WE	10D471
2	R1, R2, R3, R4	2.7M	Film Resistor, 1%	R1206	FENGHUA	
3	R5	300k	Film Resistor, 1%	R1206	FENGHUA	
4	R6, R7	150Ω	Film Resistor, 1%	R1206	FENGHUA	
5	R8	10k	Film Resistor, 1%	R1206	FENGHUA	
6	R9	22Ω	Film Resistor, 1%	R0805	FENGHUA	
7	R10	3.6Ω	Film Resistor, 1%	R0805	FENGHUA	
8	R11	18k	Film Resistor, 1%	R0805	FENGHUA	
9	R12	20k	Film Resistor, 1%	R0805	FENGHUA	
10	R13	3.9k	Film Resistor, 1%	R0805	FENGHUA	
11	R14	51Ω	Film Resistor, 1%	R0805	FENGHUA	
12	R15	11k	Film Resistor, 1%	R0805	FENGHUA	
13	RS1, RS2	2Ω	Film Resistor, 1%	R1206	FENGHUA	
14	RS3	3.6Ω	Film Resistor, 1%	R1206	FENGHUA	
15	CX	220nF	MKP62,275Vac~X2,P=10mm,T=8mm	TH	Fala	
16	C1	1nF	Ceramic Cap, 1kV X7R,1206	C1206	WE	
17	C2	100nF	Ceramic Cap, 50V X7R,0805	C0805	WE	
18	C3	47pF	Ceramic Cap, 50V NPO,0805	C0805	WE	
19	C4	22pF	Ceramic Cap, 50V NPO,0805	C0805	WE	
20	C6	680pF	Ceramic Cap, 50V NPO,0805	C0805	WE	
21	EC1	33μF	Electrolytic Cap,400V,16*20	TH	AISHI	
22	EC2	4.7μF	Electrolytic Cap, 50V,5*11.5	TH	JiangHai	
23	EC3 · EC4	680μF	Electrolytic Cap,16V,10*16	TH	AISHI	
24	L1	20mH	Common Mode Filter	EE8.3	RONGYAO	
25	L2	55μH	Common Mode Filter	9*5*3	RONGYAO	
26	D1	1kV/1A	Fast Recovery Rectifiers,TRR=150ns(VF=1.1V@IF=1A)	SMA	YEA SHIN	M7
27	D2	1kV/1A	Fast Recovery Rectifiers,TRR=130ns(VF=1.1V@IF=1A)	SOD-123S	YEA SHIN	A7
28	D3	5A/80V	5.0 AMP SCHOTTKY BARRIER RECTIFIERS	TH	PINGWEI	SB5T80
29	F1	3.15A	4T T2 AL 250V	TH	CONQUER	
30	BD1	1kV/0.8A	SINGLE PHASE SILICON BRIDGE(VF=1V@IF=0.4A)	SOP-4	SHIKUES	MB10F
31	UZ1	KP21824	High Performance Quasi-Resonant PSR CV/CC Power Switch	SOP-8	Kiwi Instruments	KP21824
32	T	EE16	EE16, L=1.15mH, Np :Ns :Naux=70:8:9	TH	ChangHui	

Transformer Manufacture Guide

1. Electrical Diagram

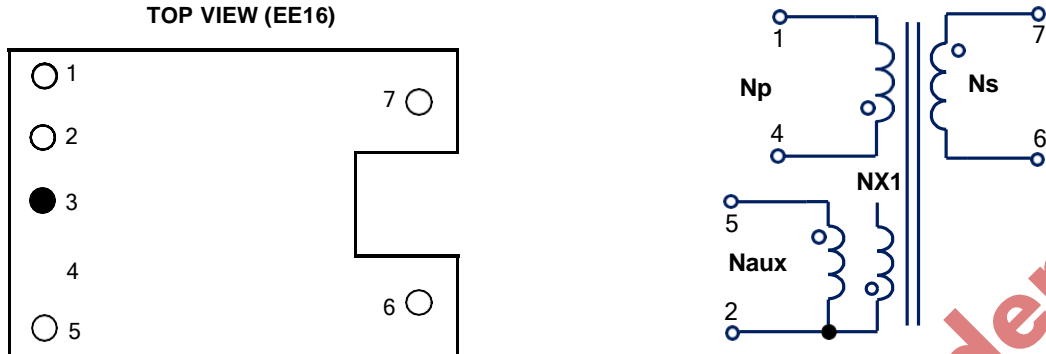

2. Winding Diagram

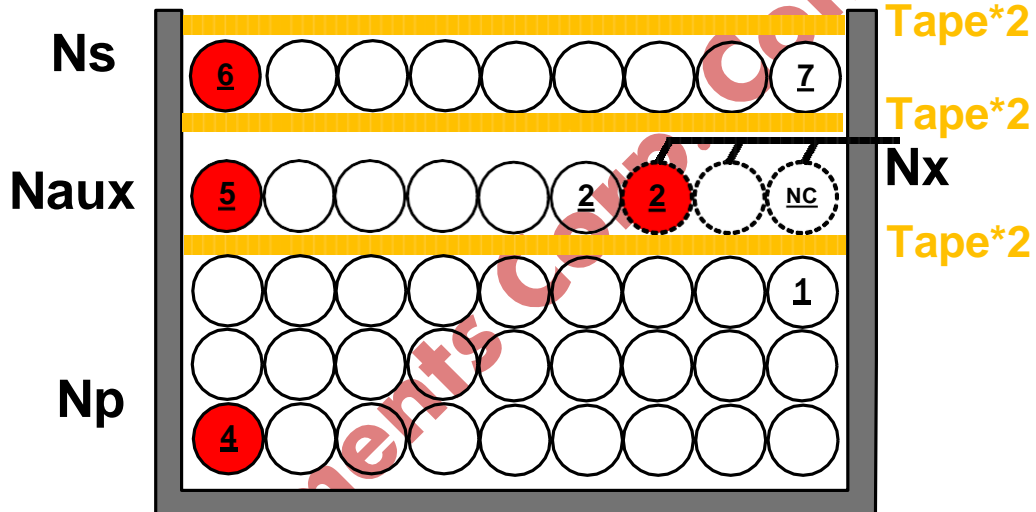

3. Winding Order

Number	Winding	Layer	Start	End	Wire Size	Turns	Note
1	N _p	Primary	4	1	0.32d*1P	70T	Dense
2	N _{aux}	Primary	5	2	0.32d*1P	9T	Dense
	N _{x1}	Primary	2	NC	0.32d*1P	3T	Spread
3	N _s	Secondary	6	7	0.8d*1P (TEX-E)	8T	Dense Reverse Wound

4. Electrical Specification

Items	Test Condition	Test Pin	Specification
Primary Inductance	Measured at 40kHz, 1.0 VRMS	Pins 4 - 1, all other windings open,	1.15mH± 5%
Primary Leakage Inductance	Measured at 40kHz, 1.0 VRMS	Pins4 - 1, all other windings shorted,	33uH
HI-POTHV Test	3500Vac/50Hz, One minute	Primary to Secondary	PASS
Insulation Resistance	500Vdc	Between windings	100MΩ Min
DC Resistance	-	Pins 4 - 1	0.8R Max

5. Transformer BOM

Items	Description
1	Core: EE16, PC95 or equivalent, AE=49mm ²
2	Bobbin: EE16, Vertical, 5+2 pin
3	Wire: 0.32φ 2UEW 130°C
4	Triple Insulation Wire: 0.8φ TEX-E 130°C
5	Tape: W=9mm



Test Result

1. Input Characteristics

1.1. Maximum rated input AC current

Standard: 0.6A max. @ 90Vac input & full load

Result: **PASS.**

$V_{IN(AC)}$	90Vac	lin_max limit(A)	Result
lin_rms	0.398A	0.6A	PASS

1.2. Inrush current (cold start)

Standard: 40Amax. @ 265Vac input

Result: **PASS.**

$V_{IN(AC)}$	linrush	lin_max limit(A)	Result
265Vac	16.2A	40A	PASS

1.3. No Load Input Power Dissipation

Standard: while input 115Vac~230Vac and the output is no load, the input power loss must be less than 75mW.

Result: **PASS.**

$V_{IN(AC)}$	115	230	green mode limit	Result
Po=0W	33.52 mW	62.01 mW	75mW	PASS



1.4. Average Efficiency

Standard: while input 115Vac and 230Vac, the average efficiency is more than 85.45%.

Test Condition: Line End (AWG 22#, 1.5m)

Result: PASS.

V _{in} (Vac)	F _{line} (Hz)	P _{in} (W)	V _{out} (V)	I _{out} (A)	P _{out} (W)	Eff (%)	Eff_AVG(%)	Standard(%)
115	60	21.17	12.05	1.5	18.075	85.38%	86.30%	85.47%
		15.663	12.04	1.125	13.545	86.48%		
		10.335	11.95	0.75	8.963	86.72%		
		5.135	11.86	0.375	4.448	86.61%		
		2.1138	11.88	0.15	1.782	84.30%	84.30%	75.47%
230	50	21.006	12.05	1.5	18.075	86.05%	85.90%	85.47%
		15.668	12.01	1.125	13.511	86.23%		
		10.396	11.95	0.75	8.963	86.21%		
		5.2346	11.88	0.375	4.455	85.11%		
		2.2326	11.88	0.15	1.782	79.82%	79.82%	75.47%

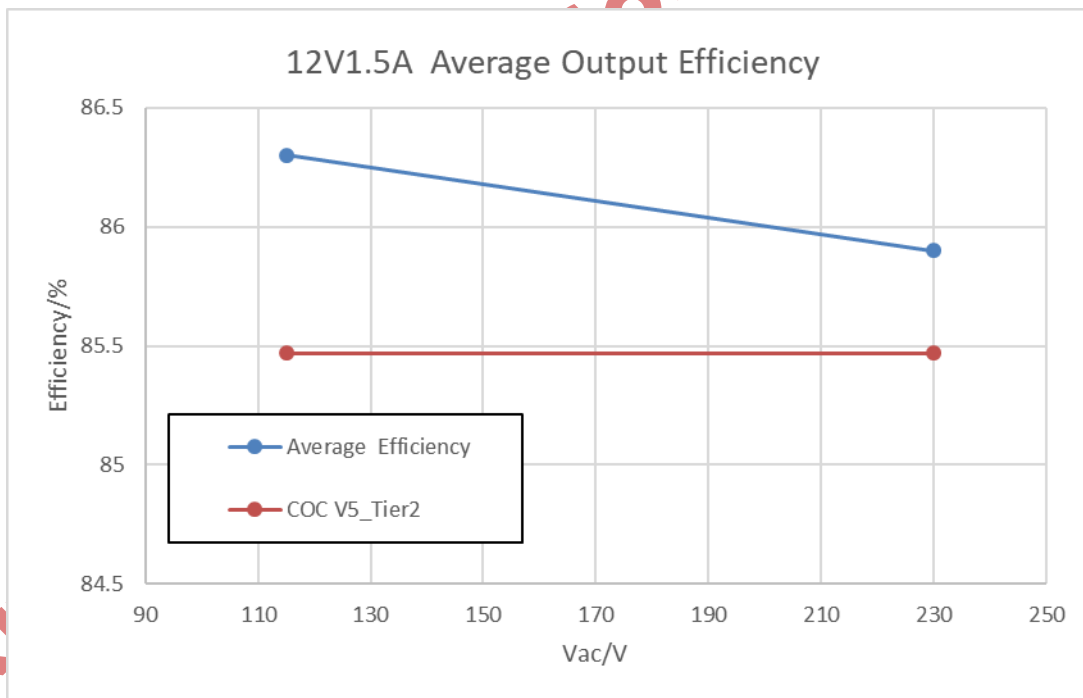



2. Output Characteristics

2.1. Ripple & Noise

Standard: under the input voltage 90Vac~265Vac, output with 1.5m AWG22# cable, $V_{ripple} < 120mV_{p-p}$.

Result: PASS.

Input Voltage	Ripple & noise	
	No Load(mV)	Full Load(mV)
90Vac/60Hz	16	84
115Vac/60Hz	16	80
230Vac/50Hz	18	54
264Vac/50Hz	16	46

Waveforms (90Vac & 265Vac):

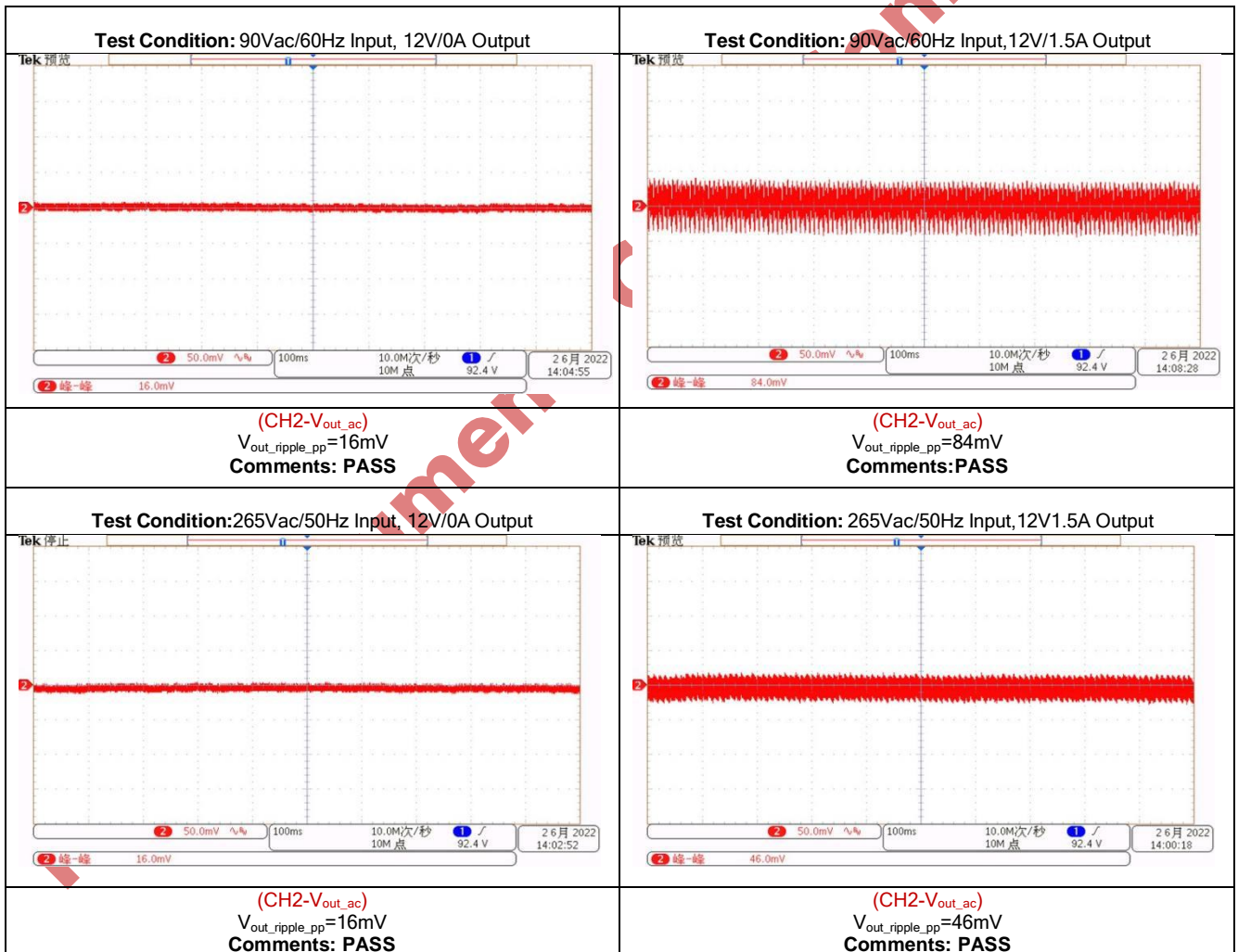



2.2. Output Voltage / Current Characteristics

Standard: Output voltage regulation < 3%, output current regulation < 3%.

Result: PASS.

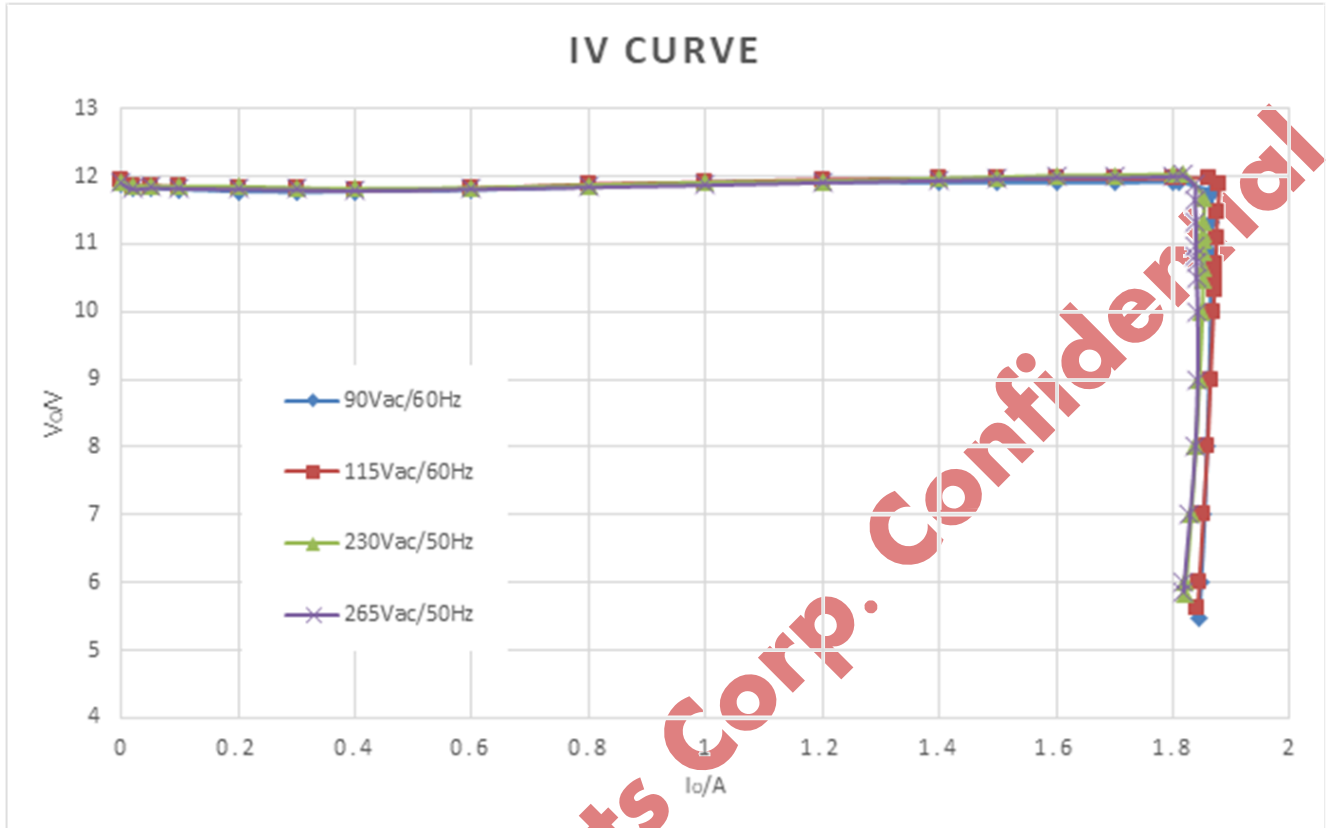

2.3. Start Time & Rise Time

Standard: Start time < 3s @ 90Vac input & full load; Rise time < 50ms @ full load.

Result: PASS.

Waveforms:

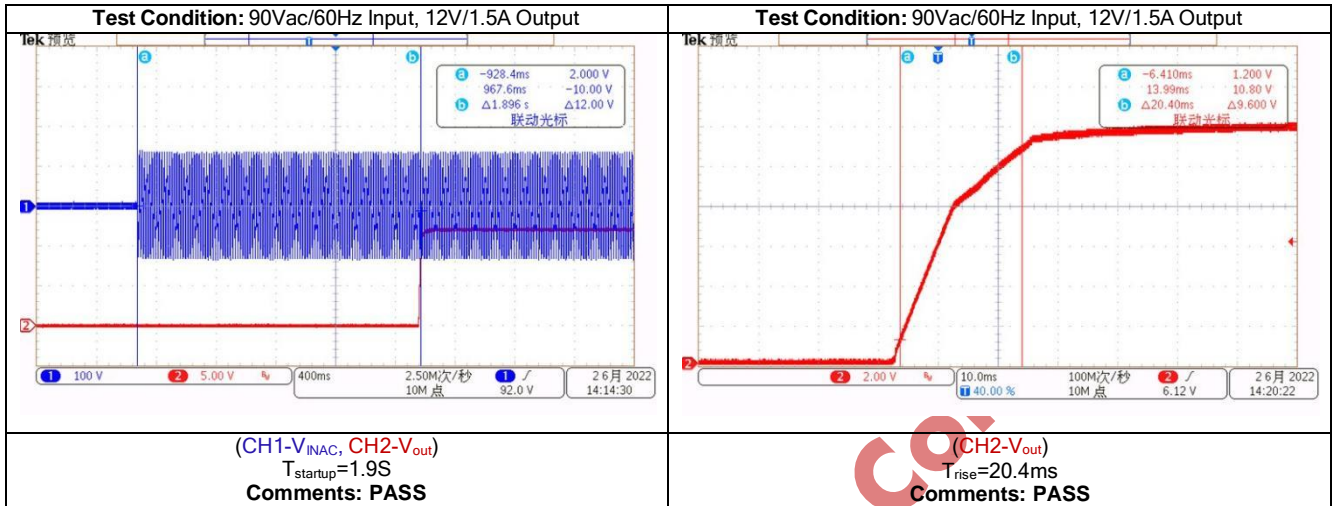

2.4. Hold-up Time

Standard: 10ms min @ 115Vac/230Vac input & full load.

Result: PASS.

Waveforms:

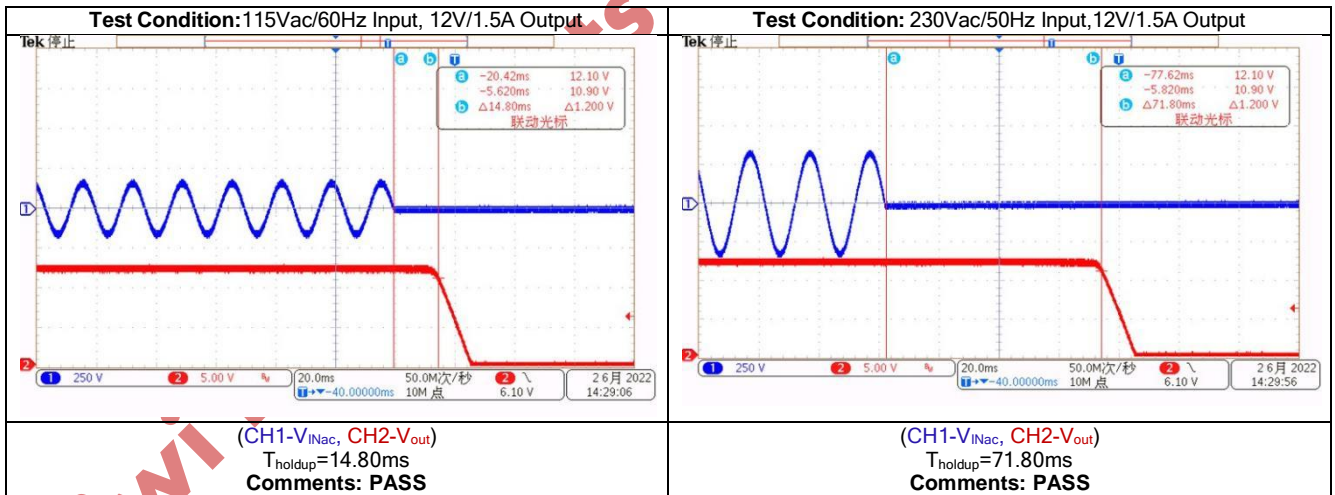

2.5. Output Overshoot

Standard: Output overshoot < 5%.

Result: PASS.

Waveforms:



Demo Board Test Report ----NO-Y 12V1.5A Adapter using QR PSR Power Switch KP21824

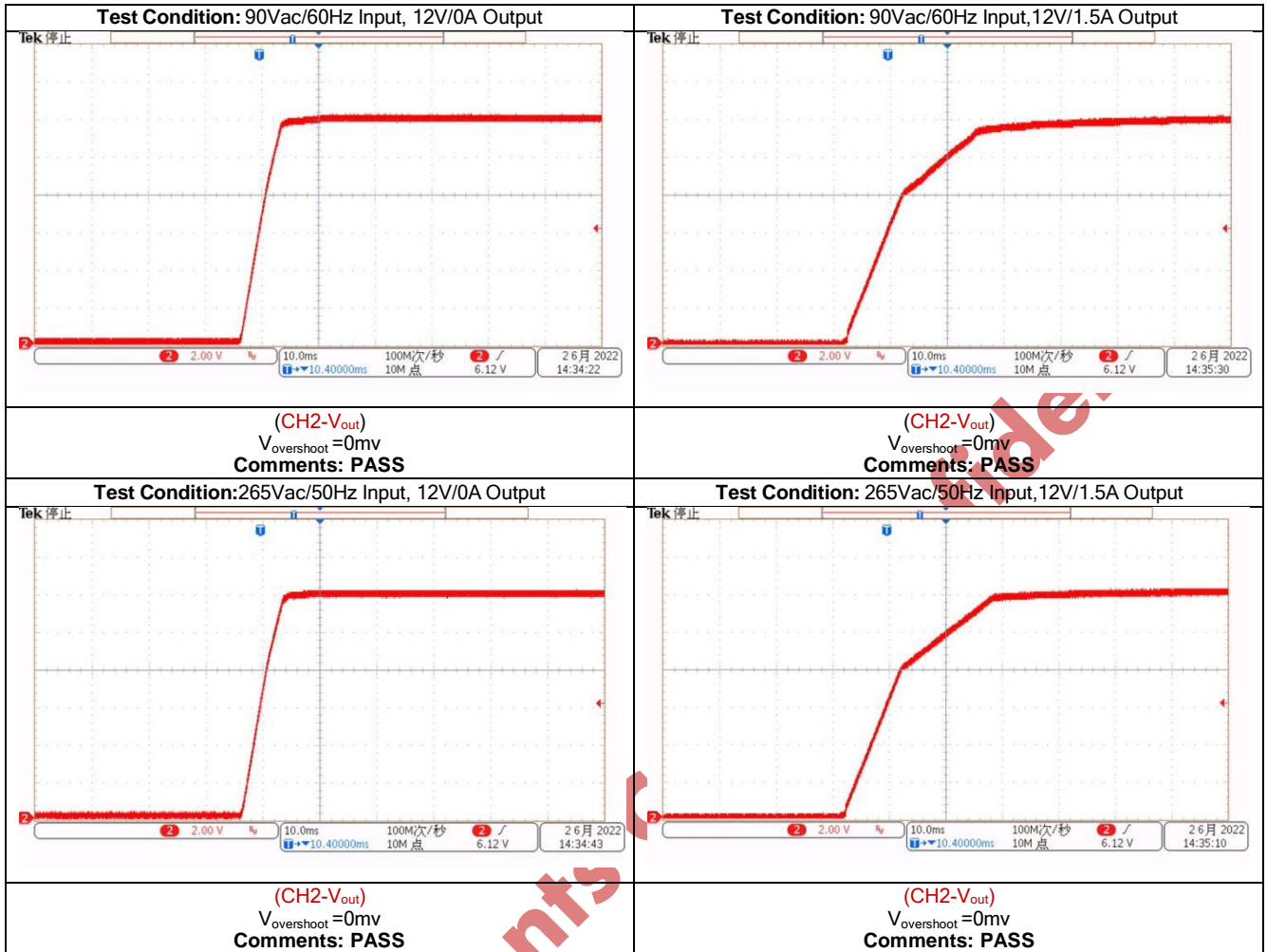

2.6. Load Transient Test

Standard:: 1)RUIDIR Standard: Under the input voltage 90Vac~265Vac, the output Voltage transient response should be within 11.4V-12.6V (25% load shift to 75% load with 0.25A/ μ s changing ramp and 250Hz changing frequency.).

2)DIWEN Standard: Under the input voltage 90Vac~265Vac, the output Voltage transient response should be within 10.2V-13.8V (10% load shift to 90% load with 0.1A/us changing ramp and 100Hz changing frequency.).

Result: PASS.

Waveforms:

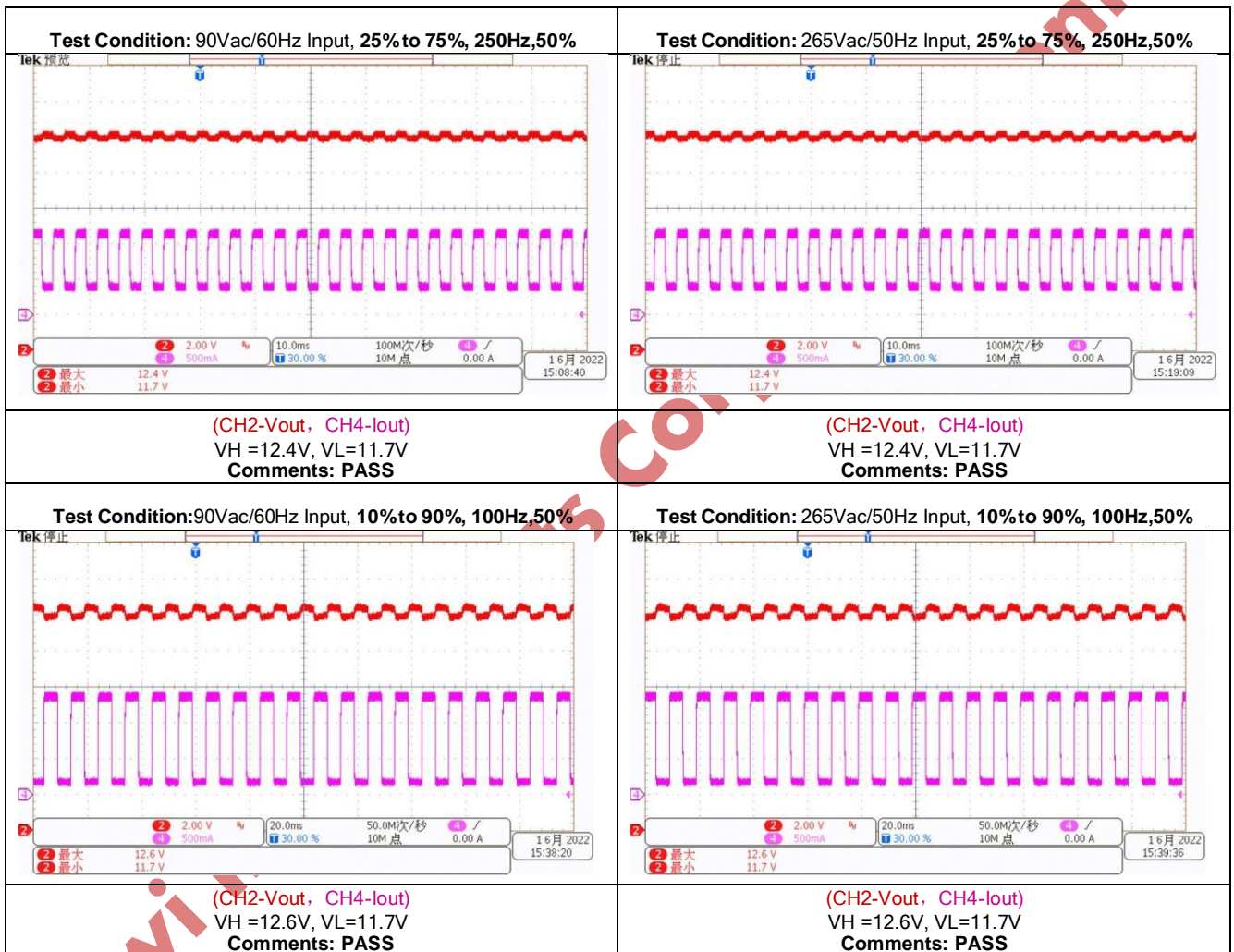

2.7. Capacitance Load Test

Standard: Capacitance load: 4000 μ F @ 12V1.5A.

Result: PASS.

Waveforms:

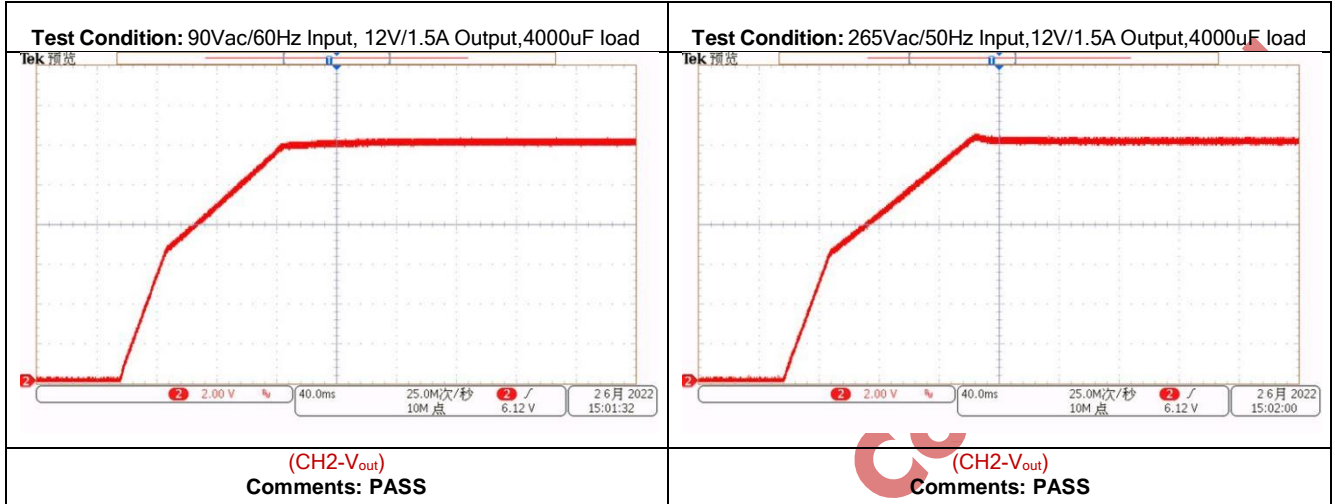

3. Protection Requirements

3.1. Over Current Protection

Standard: OCP point limited is between 1.8A~3A.

Result: PASS.

Input Voltage	OCP (A)	Standard(A)	Result
90Vac/60Hz	1.87	1.8~2.25	PASS
115Vac/60Hz	1.88	1.8~2.25	PASS
230Vac/50Hz	1.85	1.8~2.25	PASS
265Vac/50Hz	1.84	1.8~2.25	PASS

3.2. Short Circuit Protection

Standard: Shorting of output will not cause power supply to damage or any safety hazard. The power supply shall resume normal operation after short is removed.

Result: PASS.

Waveforms:

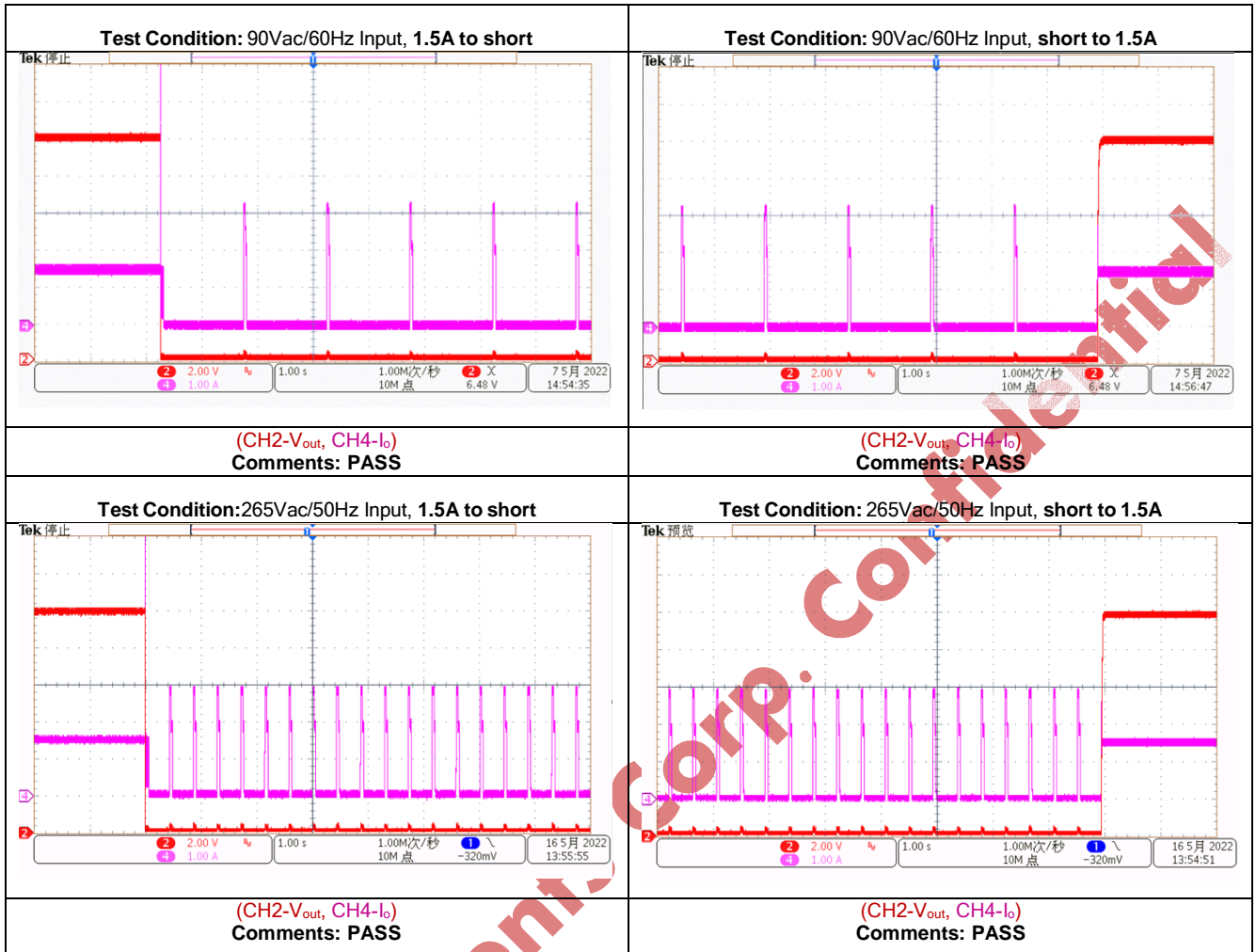

3.3. Single Failure Protections

KP21824 integrates single failure protections which can ensure no damage to IC and no over voltage of output in the event of single point of failures.

No	Single Failure Protection	Standard	Result
1	FB pull-up resistor open protection	The power supply must shut-down in the event of single failure and automatically return to normal operating condition once the fault condition has been removed. The output voltage should be less than 18V.	PASS
2	FB pull-down resistor open protection		PASS
3	FB pull-down resistor short protection		PASS
4	Transformer windings short protection		PASS
5	Rcs open protection		PASS
6	IC GND pin open protection		PASS
7	Rectifier diode or SR short protection		PASS

4. Reliability Requirements

4.1. Thermal Test

Test Condition: Ambient Temperature: 25°C and steady environment with no airflow, Ta is the temperature inside the plastic box.

Standard: IC & Diode : $\Delta T < 75^\circ\text{C}$. Transformer: $\Delta T < 70^\circ\text{C}$.

Result: PASS.

Component	90Vac		265Vac	
	$T_a = 27.3^\circ\text{C}$		$T_a = 26.1^\circ\text{C}$	
	$T_c(^{\circ}\text{C})$	$T_{rise}(^{\circ}\text{C})$	$T_c(^{\circ}\text{C})$	$T_{rise}(^{\circ}\text{C})$
KP21824	74.1	46.8	67.9	41.8
SR560L	78.9	51.6	77.8	51.7
T Core	61.1	33.8	59.4	33.3
T Windings	63.5	36.2	61.6	35.5

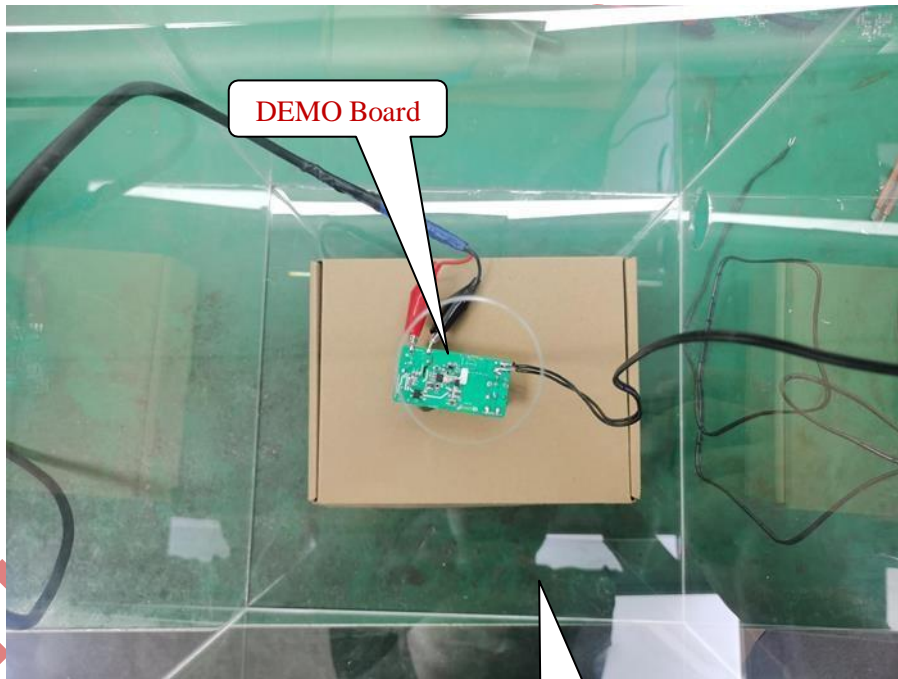

4.2. Device Maximum Rating

Standard: Steady-state MOSFET, Diode and IC <90% V_{rrm} ; dynamic-state MOSFET, Diode and IC <100% V_{rrm} .

Result: PASS.

Waveforms:

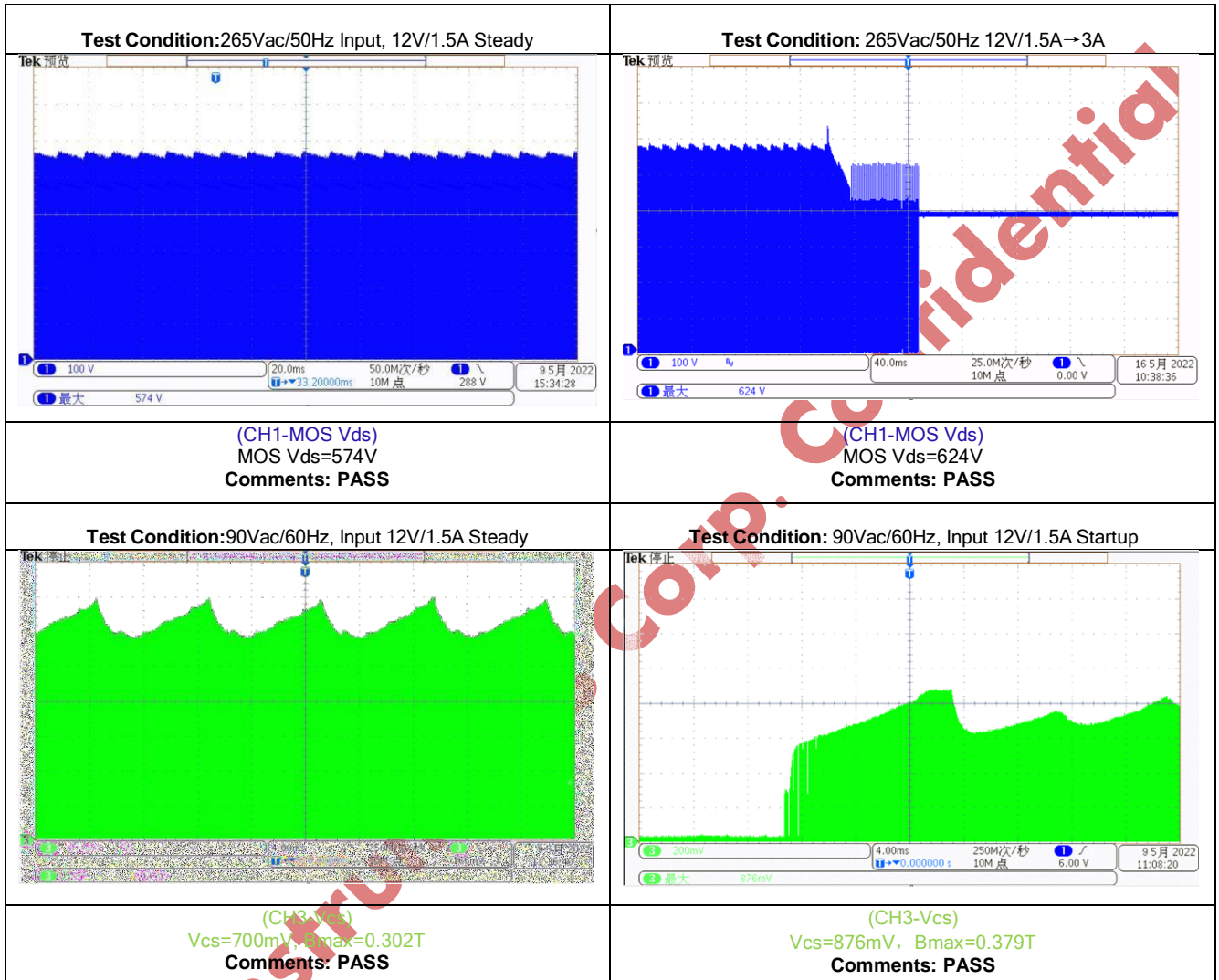



Demo Board Test Report ----NO-Y 12V1.5A Adapter using QR PSR Power Switch KP21824

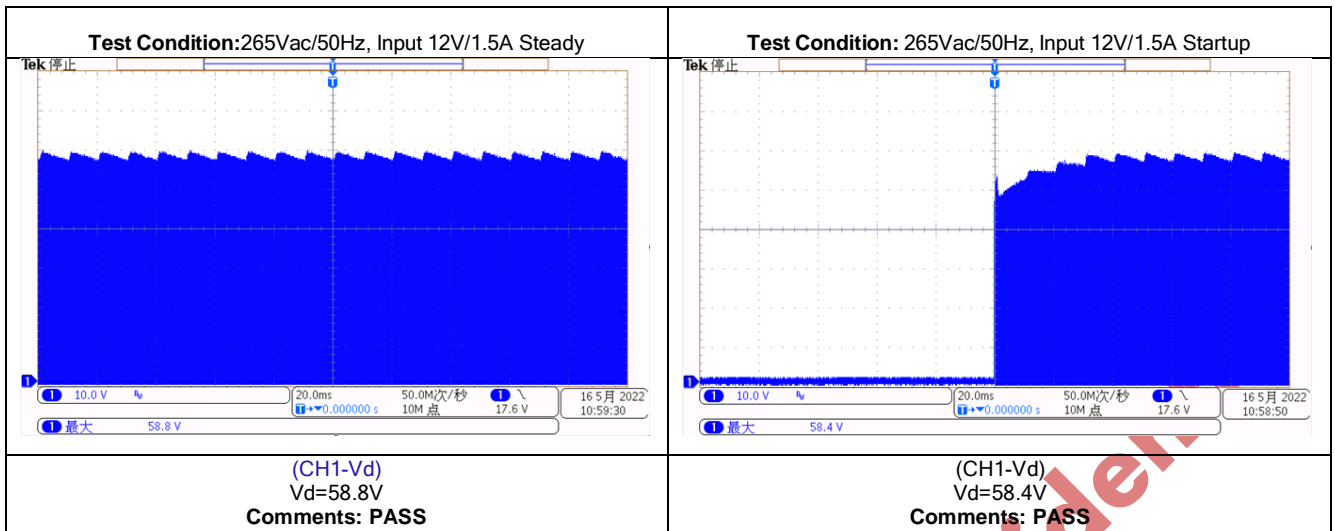

Kiwi Instruments Corp. Confidential



5. EMI/EMS

5.1. EMI Standards

standard	EN55022B/EN55032
content	CE & RE
requirement	6dB margin
Result	PASS

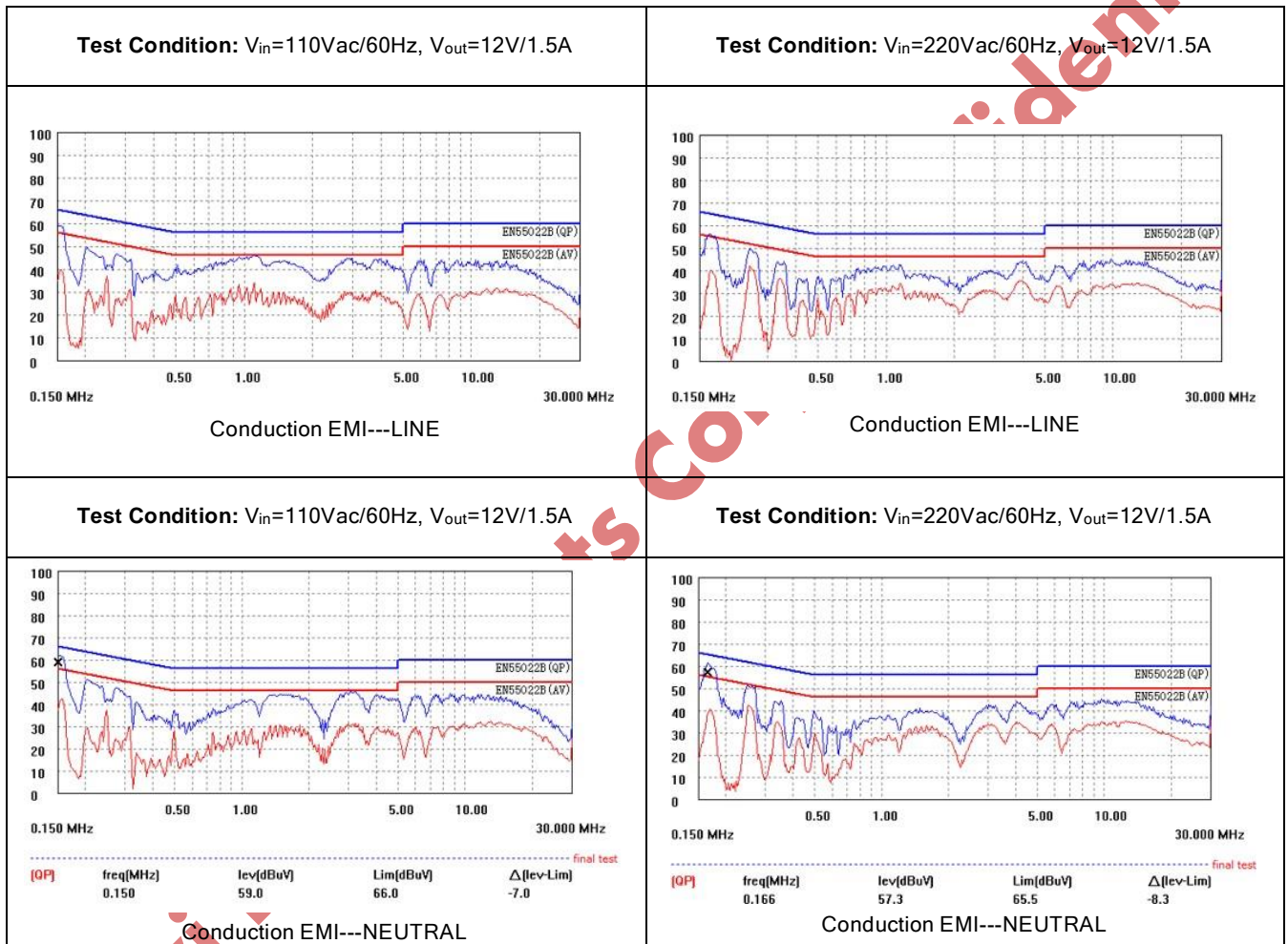

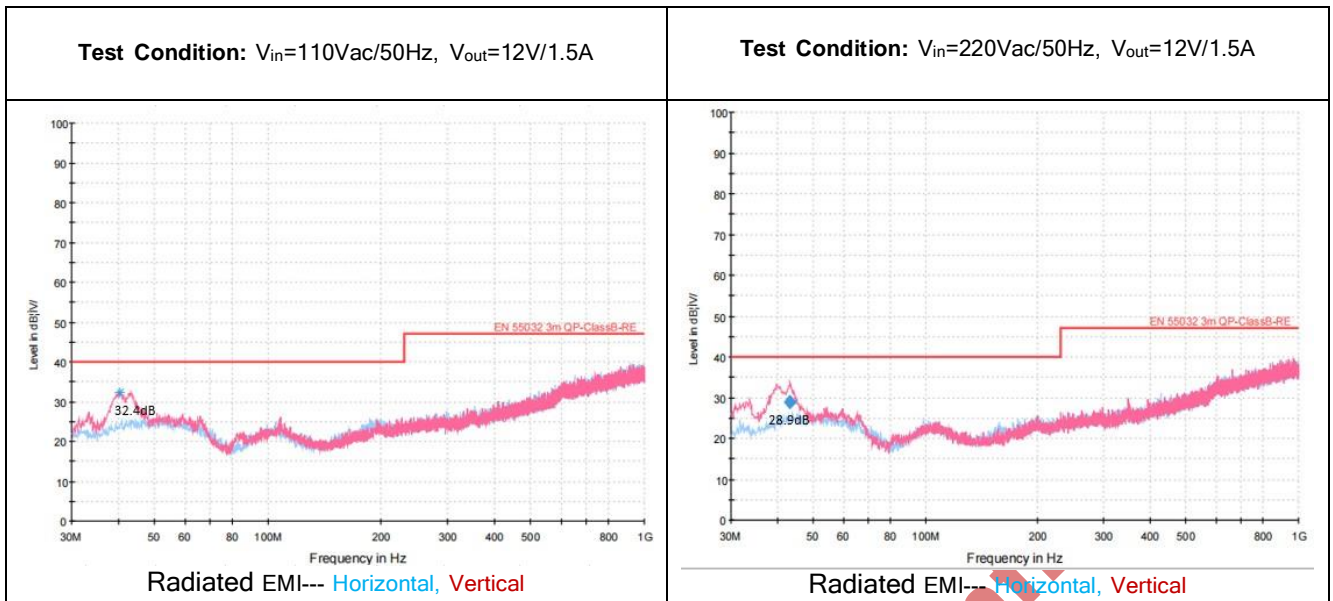

5.2. EMS Standards

5.2.1. IEC61000-4-2 (ESD)

Test Condition: Input 220Vac/50Hz, Output 12V/1.5A. Discharge 10 times on each output terminals at each test voltage according to IEC61000-4-2

Standard: Air discharge 15KV, Contact discharge 8KV

Result: PASS

Air Discharge		Contact Discharge	
Test Voltage (kV)	Air Discharge	Test Voltage (kV)	Contact Discharge
12	Pass	5	Pass
-12	Pass	-5	Pass
16	Pass	9	Pass
-16	Pass	-9	Pass

5.2.2. IEC61000-4-5 (surge)

Test Condition: Input 220Vac/50Hz, Output 12V/1.5A. Surge testing was completed according to IEC61000-4-5. Each injection phase below is tested with 5 times and hold for 60 seconds before next one.

Standard: Common mode voltage 4kV, difference mode voltage 4kV.

Result: PASS

Test Result



Demo Board Test Report ----NO-Y 12V1.5A Adapter using QR PSR Power Switch KP21824

Injection Location	Surge Level (V)	Injection Phase (°)	Test Result (Pass/Fail)
L to N	+4500	0	PASS
	+4500	90	PASS
	+4500	180	PASS
	+4500	270	PASS
	-4500	0	PASS
	-4500	90	PASS
	-4500	180	PASS
	-4500	270	PASS
L to PE	+4500	0	PASS
	+4500	90	PASS
	+4500	180	PASS
	+4500	270	PASS
	-4500	0	PASS
	-4500	90	PASS
	-4500	180	PASS
	-4500	270	PASS
N to PE	+4500	0	PASS
	+4500	90	PASS
	+4500	180	PASS
	+4500	270	PASS
	-4500	0	PASS
	-4500	90	PASS
	-4500	180	PASS
	-4500	270	PASS
L&N to PE	+4500	0	PASS
	+4500	90	PASS
	+4500	180	PASS
	+4500	270	PASS
	-4500	0	PASS
	-4500	90	PASS
	-4500	180	PASS
	-4500	270	PASS



6. Safety Standards

6.1. Dielectric Strength (Hi-pot)

Standard: primary to secondary: 3500Vac / 5mA /60 seconds.

V(AC)	time	I _{leak} (mA)	Result
3.5kV	60s	0.21	PASS

Kiwi Instruments Corp. Confidential



Revision History

DATE	REV	DESCRIPTION
2022/06/02	1.0	First Release

Kiwi Instruments Corp. Confidential

Disclaimer

Kiwi reserves the right to make any change to its product, datasheet or specification without any notice. Users shall obtain the latest information before placing an order. Kiwi herein makes no guarantee or warranty, expressed or implied, including without limitation the warranties of merchantability, fitness for any purpose or non-infringement of third party rights, nor does Kiwi convey any license or permission including without limitation the intellectual property rights of Kiwi or any third party. Users should warrant that third party intellectual property right or other right is not infringed when integrating Kiwi products into any application or in use. Kiwi will not assume any liability arising from any said application or use, and especially disclaim any liability including without limitation any consequential or incidental damage. Without written declaration, Kiwi products are not designed for use in surgical device implant into the body or other life sustain systems. This disclaimer supersedes the disclaimers in previous versions.